

STANDARD EQUIPMENT

ENGINE

- Engine, HINO J05E, Diesel engine with turbocharger and intercooler
- Automatic engine deceleration
- Auto Idle Stop (AIS)
- Batteries (2 x 12V - 96Ah)
- Starting motor (24V - 5 kW), 50 amp alternator
- Removable clean-out screen for radiator
- Automatic engine shut-down for low engine oil pressure
- Engine oil pan drain valve
- Double element air cleaner

CONTROL

- Working mode selector (H-mode and S-mode)
- Power Boost

SWING SYSTEM & TRAVEL SYSTEM

- Swing rebound prevention system
- Straight propel system
- Two-speed travel with automatic shift down
- Sealed & lubricated track links
- Grease-type track adjusters
- Automatic swing brake

HYDRAULIC

- Arm regeneration system
- Aluminum hydraulic oil cooler

MIRRORS & LIGHTS

- Two rearview mirrors
- Two front and two rear working lights
- Swing flashers
- Two cab working lights

CAB & CONTROL

- Two control levers, pilot-operated
- Tow eyes
- Horn, electric
- Integrated left-right slide-type control box
- Cab, all-weather sound suppressed type
- Ashtray
- Cigarette lighter
- Cab light (interior)
- Coat hook
- Luggage tray
- Large cup holder
- Detachable two-piece floor mat
- Double slide seat
- Adjustable suspension seat
- Retractable seatbelt
- Headrest
- Handrails
- Heater and defroster
- Intermittent windshield wiper with double-spray washer
- Skylight
- Tinted safety glass
- Pull-type front window and removable lower front window
- Easy-to-read multi-display monitor
- Automatic air conditioner
- Emergency escape hammer

OPTIONAL EQUIPMENT

- Radio, AM/FM Stereo with speakers
- Wide range of buckets
- Various optional arms
- Wide range of shoes
- Boom safety valve

- Arm safety valve
- 7-way adjustable suspension seat
- Front-guard protective structures
- Additional hydraulic circuit
- Pre-air cleaner

Note: Standard and optional equipment may vary. Consult your KOBELCO dealer for specifics.

Note: This catalog may contain attachments and optional equipment that are not available in your area. And it may contain photographs of machines with specifications that differ from those of machines sold in your areas. Please consult your nearest KOBELCO distributor for those items you require. Due to our policy of continuous product improvements all designs and specifications are subject to change without advance notice. Copyright by **KOBELCO CONSTRUCTION MACHINERY CO., LTD.** No part of this catalog may be reproduced in any manner without notice.

KOBELCO CONSTRUCTION MACHINERY CO., LTD.

17-1, Higashigotanda 2-chome, Shinagawa-ku, Tokyo 141-8626 JAPAN
Tel: +81 (0) 3-5789-2146 Fax: +81 (0) 3-5789-2135
www.kobelco-kenki.co.jp/english_index.html

Inquiries To:

Bulletin No. ACERA GEOSPEC SUPER SK200/SK210LC-MONGOL-101
2011113000IF Printed in Japan

Hydraulic Excavators

ACERA
GEOSPEC
SUPER

SK200
SK210_{LC}

- Bucket Capacity:
0.8 – 1.0 m³ ISO heaped
- Engine Power:
118kW {160 PS}/2,000 min⁻¹{rpm}
(ISO14396)
- Operating Weight:
20,800 kg–SK200
21,300 kg–SK210LC

We Save You Fuel
Achieving a Low-Carbon Society

The Power Wave of Change

Announcing ACERA GEOSPEC and the Concept of Beautiful Performance.

When we set out to design our new hydraulic excavators, we kept our eyes on the big picture. Of course we wanted machines with greater digging capacity. But they also had to be fuel-efficient and economical, while imposing less of a burden on the local and global environments. Applying our advanced technologies, we developed KOBELCO's new ACERA GEOSPEC series, an entirely new kind of excavator that beautifully balances all the demands of today's construction industry. Lean and efficient with capacity to spare, these sleek powerhouses bring a whole new style to the worksite while setting new standards for environmental responsibility.

Photos in this catalog are the optional specs with 0,93 m³ bucket and 800 mm shoes.



NEXT-3E



Pursuing the "Three E's"
The Perfection of Next-Generation,
Network Performance

Enhancement

Greater Performance Capacity

- New hydraulic circuitry minimizes pressure loss
- High-efficiency, electronically controlled Common Rail Fuel Injection Engine
- Powerful travel and arm/bucket digging force

Economy

Improved Cost Efficiency

- Advanced power plant that reduces fuel consumption
- Easy maintenance that reduces upkeep costs
- High structural durability and reliability that retain machine value longer

Environment

Features That Go Easy on the Earth

- Auto Idle Stop as standard equipment
- Noise reduction measures (with improvement of the sound quality) minimize noise and vibration

**ACERA
GEOSPEC** ACERA GEOSPEC

The "GEO" in GEOSPEC expresses our deep respect for our planet, and for the solid ground where excavators are in their element. This is accompanied by SPEC, which refers to the performance specifications needed to get the job done efficiently as we carry on the tradition of the urban-friendly ACERA series.

The GEOSPEC Difference: Efficient Performance!

Amazing Productivity with a 20 % Decrease in Fuel Consumption and "Top-Class" Cost-Performance

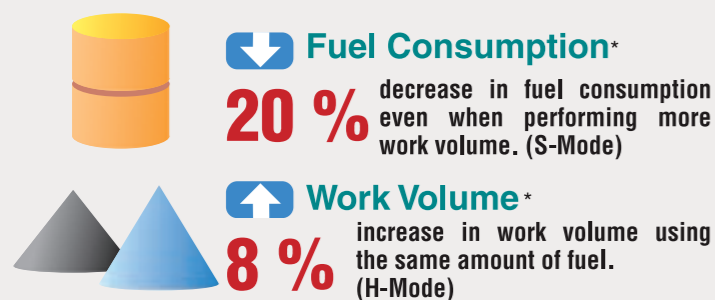

"Top-Class" Powerful Digging

Max. arm crowding force: **102 kN** {10.4 tf} ↑

Max. arm crowding force with power boost: **112 kN** {11.4 tf} ↑

Max. bucket digging force: **143 kN** {14.6 tf}

Max. bucket digging force with power boost: **157 kN** {16.0 tf}

Powerful Travel

Travel torque: increased by **16 %** ↑

Drawbar pulling force: **229 kN** {23.3 tf} ↑

Greater Swing Power, Shorter Cycle Times

Swing torque: increased by **10 %** ↑

Swing speed: **11 %** ↑
faster (12.5 min⁻¹)

Significant Extension of Continuous Working Hours

The combination of a large-capacity fuel tank and excellent fuel efficiency delivers an impressive 30 % increase in continuous operation hours. One tank of fuel keeps the machine operating under high-load conditions for more than 20 hours.**

Fuel tank: 370 L
30 % ↑

Light Lever Operation

It takes 10% less effort to move the control levers, so that operators can work longer hours with less fatigue.

10 % Less



Photos in this catalog are the optional specs with 0.93 m³ bucket and 800 mm shoes.

NEXT-3E Technology Next-Generation Electronic Engine Control

The high-pressure, common-rail fuel-injection engine features adjustable control to maximize fuel efficiency and provide powerful medium/low-speed torque. The result is a highly fuel-efficient engine.



Simple Select: Two Digging Modes

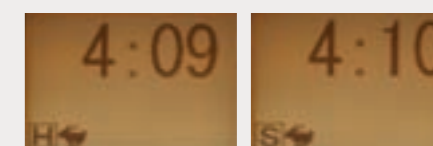

- H** For heavy duty when a higher performance level is required.
H-Mode
- S** For normal operations with lower fuel consumption.
S-Mode

Optional N&B (crusher and breaker)

The operator selects the desired mode from inside the cab, and the selector valve automatically configures the machine accordingly.

Attachment Mode Selector Switch (Optional)

There's a choice of three different hydraulic circuits, to accommodate bucket, crusher or breaker, and the desired attachment mode can be selected with a switch, which automatically configures the selector valve. All attachment modes can be used in either S-mode or H-mode.

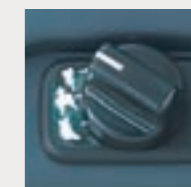

Seamless, Smooth Combined Operations

The GEOSPEC machines have inherited the various systems that make inching and combined operations easy and accurate, with further refinements that make a good thing even better. Leveling and other combined operations can be carried out with graceful ease.

- Electronic Active Control System
- Arm regeneration system
- Boom lowering system
- Variable swing priority system
- Swing rebound prevention system

NEXT-3E Technology New Hydraulic System



Rigorous inspections for pressure loss are performed on all components of the hydraulic piping, from the spool of the control valve to the connectors. This regimen, combined with the use of a new, high-efficiency pump, cuts energy loss to a minimum.

NEXT-3E Technology Total Tuning Through Advanced ITCS Control

The next-generation engine control is governed by a new version of ITCS, which responds quickly to sudden changes in hydraulic load to ensure that the engine runs as efficiently as possible with a minimum of wasted output.

ITCS (Intelligent Total Control System) is an advanced, computerized system that provides comprehensive control of all machine functions.

*The value shows results from actual measurements taken by KOBELCO when compared with previous KOBELCO models.
 **The value shows results from actual measurements taken by KOBELCO for continuous operation in S Mode, compared with previous models.
 Results vary depending on the method of operation and load conditions.

The GEOSPEC Difference:

The Value and Quality of Sturdy Construction!

Stable Attachment Strength

Forged and cast components are used throughout. The arm tip's cross-sectional coefficient is 15 % higher than previous models, giving the arm the same strength as the 3-faced reinforced arm that was offered only as an option before. The strength of the boom foot has also been increased by 18 %.



Forged steel arm foot boss



Integrated cast steel boom top



Cast steel boom foot boss



Pre-air cleaner

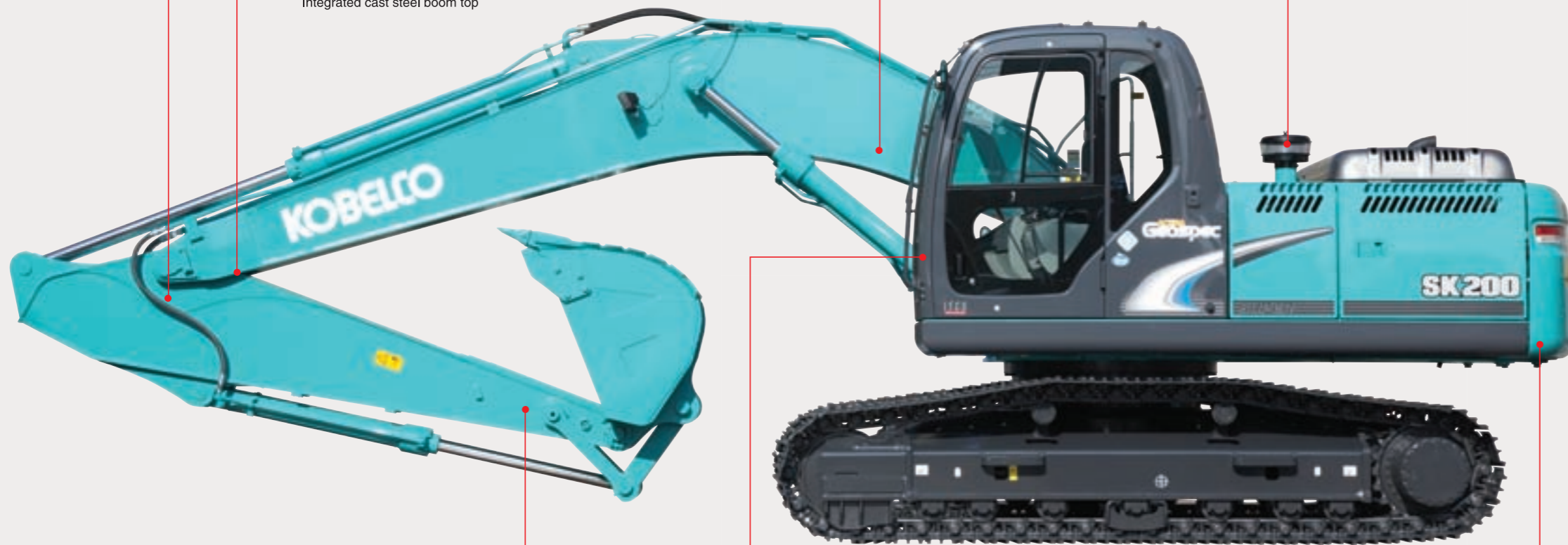

15 % strength up around arm top section

Durability That Retains Machine Value Five and Ten Years in the Future

- New operator's seat covered in durable material
- High-quality urethane paint
- Easily repaired bolted hand rails

Enhanced Upper Carbody Strength

The structure of the lower portion of the upper frame has been reassessed and the undercover area has been minimized. Also, the side deck's cross-sectional strength has been boosted by 50 %.

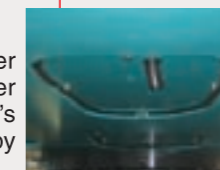

Emergency Acceleration (Dial) Permits Continued Operation in the Unlikely Event of Malfunction



If unexpected trouble is experienced with the ITCS mechatronic control system, the machine can still be operated using the emergency acceleration system. Digging modes are also automatically relayed to an emergency system so that digging can continue temporarily until a service person arrives to repair the primary system.

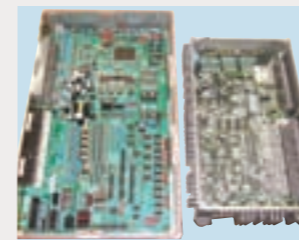
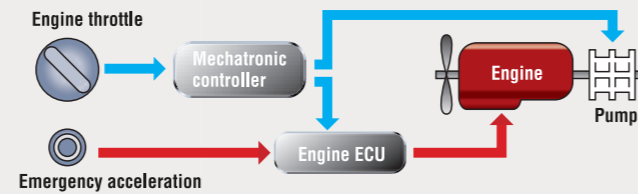

New MCU

Conventional MCU

Newly designed MCU

- Vertical alignment and sealed-cover gives better protection from water and dust
- Integration in base plate boosts assembly quality
- Reliable fixture to base plate

Countermeasures Against Electrical System Failure

All elements of the electrical system, including controller, have been designed for enhanced reliability.

The GEOSPEC Difference:

Designed for the Environment and the Future!

Auto Idle Stop Provided as Standard Equipment

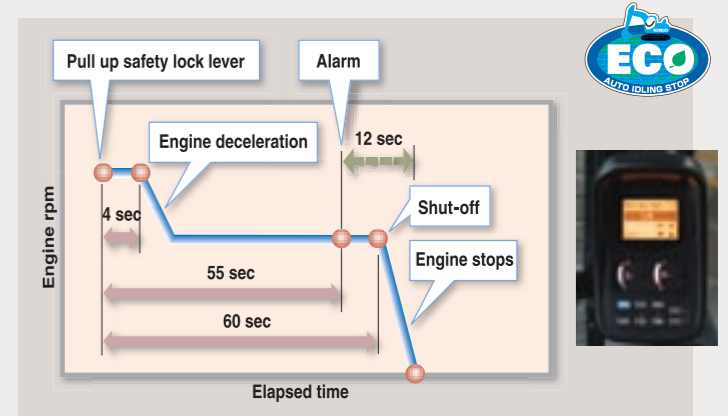

This function saves fuel and cuts emissions by shutting down the engine automatically when the machine is on stand by. It also stops the hourmeter, which helps to retain the machine's asset value.

Automatic Acceleration/Deceleration Function Reduces Engine Speed

Engine speed is automatically reduced when the control lever is placed in neutral, effectively saving fuel and reducing noise and exhaust emissions. The engine quickly returns to full speed when the lever is moved out of neutral.

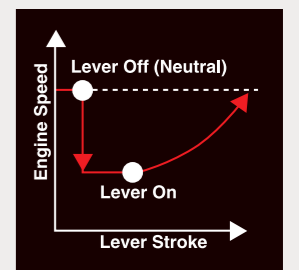

Low Noise Level and Mild Sound Quality

The electronically controlled common-rail engine has a unique fuel injection system that runs quietly. Also, the hydraulic pumps have been redesigned to produce a more pleasant sound during pressure relief.

Meets EMC (Electromagnetic Compatibility) Standards in Europe.

Measures have been taken to ensure that the GEOSPEC machines do not cause electro-magnetic interference.

The GEOSPEC Difference:

“On the Ground” Maintenance!

Comfortable “On the Ground” Maintenance



The machine layout was designed with easy inspection and maintenance in mind.

Access through the right side cover

A new fuel filter has been installed that can handle the most punishing conditions. It now has two pre-fuel filters (with built-in water separators), and a high-grade main fuel filter.

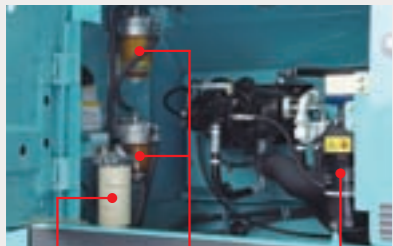

Main fuel filter
Pre-fuel filter (with built-in water separators)
Engine Oil Filter
Main fuel filter

Quick Oil Drain Valves for Quick Maintenance

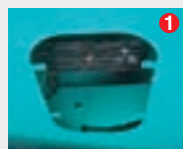

Quick drain valve



Fuel drain valve

More Efficient Maintenance Inside the Cab

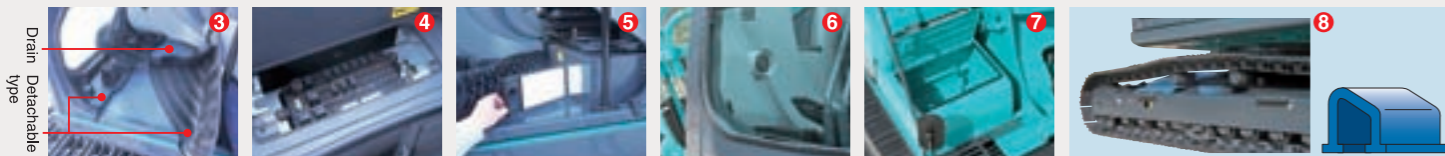

- Detachable two-piece floor mat with handles for easy removal. A floor drain is located under the mat.
- Easy-access fuse box. More finely differentiated fuses make it easier to locate malfunctions.
- Air conditioner filter can be easily removed without tools for cleaning.
- Hour meter can be checked while standing on the ground.
- Large-capacity tool box can hold up to three pails.
- Special crawler frame design is easily cleaned of mud.

Access through the left side cover

Parallel Cooling Units Are Easy to Clean

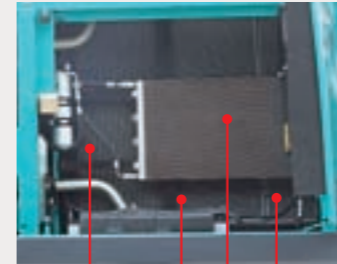

Oil cooler
Radiator
Intercooler
Air conditioner condenser

Highly Durable Super-fine Filter



● Super-fine filter

The high-capacity hydraulic oil filter incorporates glass fiber with superior cleaning power and durability. With a replacement cycle of 1,000 hours and a construction that allows replacement of the filter element only, it's both highly effective and highly economical.

Double-Element Air Cleaner as Standard



The large-capacity element features a double-filter structure that keeps the engine running clean even in dusty environments.

● Air cleaner (double element)

Monitor Display with Essential Information for Accurate Maintenance Checks



- Displays only the maintenance information that's needed, when it's needed.
- Self-diagnostic function that provides early-warning detection and display of electrical system malfunctions.
- Record previous breakdowns, including irregular and transient malfunctions.

Choice of 16 Languages for Monitor Display

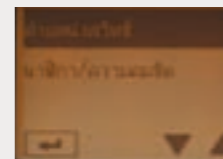

With messages including those requiring urgent action displayed in the local language, users in all parts of the world can work with greater peace of mind.

充電不良	Lichtmaschine defekt	CHARGE ERROR	CHARGE ERROR
Chinese	German	English	English (US)
ERREUR DE CHARGE	PENGISIAN BATT. RUSAK		ERRORE DI CARICA
French	Indonesian	ISO	Italian
充電	KESALAHAN CAS	အမှားပုံစံ	ERRO DE CARGA
Japanese	Malay	Myanmar (Brumee)	Portuguese
ERROR EN CARGA	தவறாக திணித்தல்	အမှားပုံစံ	Sạc Điện Bị Lỗi
Spanish	Tamil	Thai	Vietnamese

The GEOSPEC Difference: Designed from the Operator's Point of View



Newly Designed Information Display Prioritizes Visual Recognition

The analog gauge provides information that's easy to read regardless of the operating environment. The information display screen has been enlarged, and a visor is attached to further enhance visibility.

Wide Field of View Liberates the Operator

The front field of view easily clears ISO standards, while the peripheral view reduces blind spots to a minimum.



- A long wiper covers a wide area for a broad view in bad weather.
- Back mirrors provide a safe view of the rear.
- Reinforced green glass windows meet European standards.

Wide-Access Cab Ensures Smooth Entry and Exit

The left control box lifts up with the safety lock lever to add 10° to the cab entry angle for easy entrance and exit.

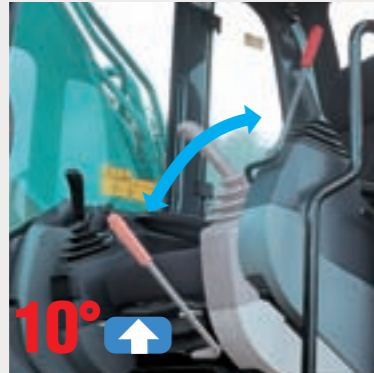

Photos in this catalog are Japanese specs.

Plenty of Foot Room

With a total width of 1,005 mm, the cab has 35 mm more front to-back foot room than previous models. The travel pedal is larger for greater operator comfort.

Reduced Vibration for Fatigue-Free Operation

The rigid cab construction and liquid-filled viscous cab mounts minimize cab vibration. In addition, the use of new lower rollers on the crawlers cuts travel vibration in half compared with previous models.

In-Cab Noise is Reduced by 3dB Compared with Previous Models.

Creating a Comfortable Operating Environment



● Seat can be reclined to horizontal position



● Double slide seat



● Powerful automatic air conditioner



● Spacious luggage tray



● One-touch lock release simplifies opening and closing the front window



● Large cup holder

- Two-speaker FM radio with station select (Optional)
- New interior design and materials create an elegant feel



The GEOSPEC Difference: Imagining Possible Scenarios and Preparing in Advance

Bracket for Attaching a Head Guard Provided as Standard Equipment



A bracket is provided as standard equipment that allows the optional head guard to be simply bolted on.

Safety Features That Take Various Scenarios into Consideration



● Firewall separates the pump compartment from the engine



● Hammer for emergency exit



● Swing flashers/rear working lights

- Thermal guard prevents contact with hot components during engine inspections
- Hand rails meet European standards
- Retractable seatbelt requires no manual adjustment

Other Features



● Two cab working lights



● Adjustable suspension seat

Engine

Model	HINO J05E
Type:	Direct injection, water-cooled, 4-cycle diesel engine with turbocharger, intercooler
No. of cylinders:	4
Bore and stroke:	112 mm X 130 mm
Displacement:	5.123 L
Rated power output:	118 kW/2,000 min ⁻¹ (ISO14396:2002) 114 kW/2,000 min ⁻¹ (ISO9249:2007)*
Max. torque:	592 N·m/1,600 min ⁻¹ (ISO14396:2002) 572 N·m/1,600 min ⁻¹ (ISO9249:2007)*

*Previous indication

Hydraulic System

Pump	
Type:	Two variable displacement pumps + 1 gear pump
Max. discharge flow:	2 X 220 L/min, 1 X 20 L/min
Relief valve setting	
Boom, arm and bucket:	34.3 MPa {350 kgf/cm ² }
Power Boost:	37.8 MPa {385 kgf/cm ² }
Travel circuit:	34.3 MPa {350 kgf/cm ² }
Swing circuit:	29.0 MPa {296 kgf/cm ² }
Control circuit:	5.0 MPa {50 kgf/cm ² }
Pilot control pump:	Gear type
Main control valves:	8-spool
Oil cooler:	Air cooled type

Swing System

Swing motor:	Axial-piston motor
Brake:	Hydraulic; locking automatically when the swing control lever is in the neutral position
Parking brake:	Hydraulic disc brake
Swing speed:	12.5 min ⁻¹ {rpm}
Tail swing radius:	2,750 mm
Min. front swing radius:	3,540 mm

Attachments

Backhoe bucket and arm combination

Use	Backhoe bucket		
	Normal digging		
Bucket capacity	ISO heaped m ³	0.8	1.0
	Struck m ³	0.59	0.76
Opening width	With side cutters mm	1,060	1,410
	Without side cutters mm	1,130	1,390
No. of bucket teeth		5	5
Bucket weight	kg	810	950
Combinations	2.40 m short arm	—	○
	2.94 m standard arm	○	—

○ Recommend

Travel System

Travel motors:	2 X axial-piston, two-step motors
Travel brakes:	Hydraulic disc brake
Parking brakes:	Oil disc brake per motor
Travel shoes:	46 each side (SK200) 49 each side (SK210LC)
Travel speed:	6.0/3.6 km/h
Drawbar pulling force:	229 kN {23.3 tf} (ISO 7464)
Gradeability:	70 % {35°}
Ground clearance:	450 mm

Cab & Control

Cab	
All-weather, sound-suppressed steel cab mounted on the silicon-sealed viscous mounts and equipped with a heavy, insulated floor mat.	
Control	
Two hand levers and two foot pedals for travel	
Two hand levers for excavating and swing	
Electric rotary-type engine throttle	

Boom, Arm & Bucket

Boom cylinders:	120 mm X 1,355 mm
Arm cylinder:	135 mm X 1,558 mm
Bucket cylinder:	120 mm X 1,080 mm

Refilling Capacities & Lubrications

Fuel tank:	370 L
Cooling system:	22 L
Engine oil:	22 L
Travel reduction gear:	2 X 5.3 L
Swing reduction gear:	3.0 L
Hydraulic oil tank:	146 L tank oil level 230 L hydraulic system

Working Ranges

Range	Arm	5.65 m	
		Short 2.4 m	Standard 2.94 m
a - Max. digging reach		9.42	9.9
b - Max. digging reach at ground level		9.24	9.73
c - Max. digging depth		6.16	6.7
d - Max. digging height		9.51	9.72
e - Max. dumping clearance		6.68	6.91
f - Min. dumping clearance		2.98	2.43
g - Max. vertical wall digging depth		5.57	6.1
h - Min. swing radius		3.56	3.54
i - Horizontal digging stroke at ground level		4.08	5.27
j - Digging depth for 2.4 m (8') flat bottom		5.95	6.52
Bucket capacity ISO heaped m ³	SK200	1.0	0.8
	SK210LC	1.0	1.0

Digging Force (ISO 6015)		
Arm length	Short 2.4 m	Standard 2.94 m
Bucket digging force	143 {14.6}	143 {14.6}
	157 {16.0}*	157 {16.0}*
Arm crowding force	121 {12.3}	102 {10.4}
	133 {13.6}*	112 {11.4}*

*Power Boost engaged.

Dimensions

Arm length	Short 2.4 m	Standard 2.94 m
A Overall length	9,640	9,560
B Overall height (to top of boom)	3,160	2,980
	SK200 2,800	2,800
SK210LC 2,990	2,990	
D Overall height (to top of cab)	3,030	3,030
E Ground clearance of rear end*	1,060	1,060
F Ground clearance*	450	450

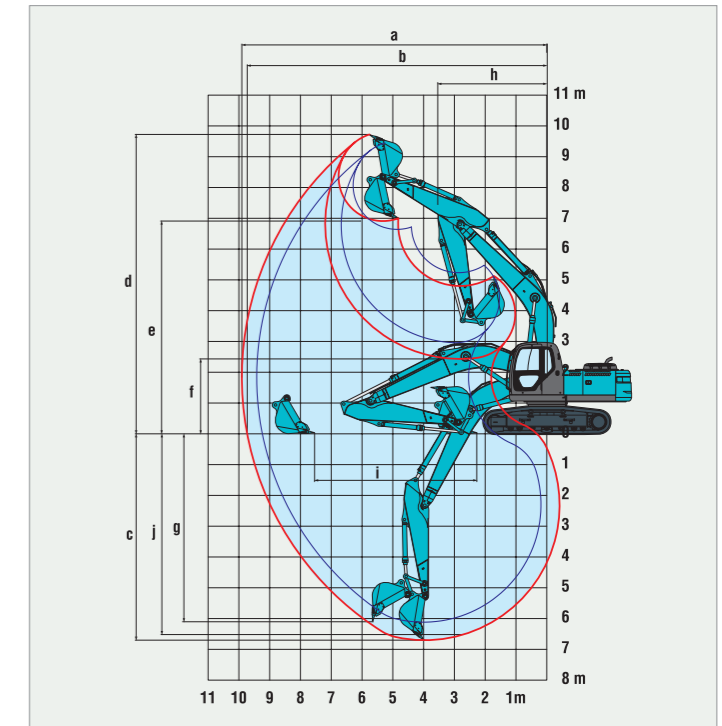

— Short Arm
— Standard Arm

Dimensions			Unit: mm
G Tail swing radius			2,860
G' Distance from center of swing to rear end			2,860
H Tumbler distance	SK200		3,370
	SK210LC		3,660
I Overall length of crawler	SK200		4,170
	SK210LC		4,450
J Track gauge	SK200		2,200
	SK210LC		2,390
K Shoe width			600/700/800
L Overall width of upperstructure			2,710

* Without including height of shoe lug.

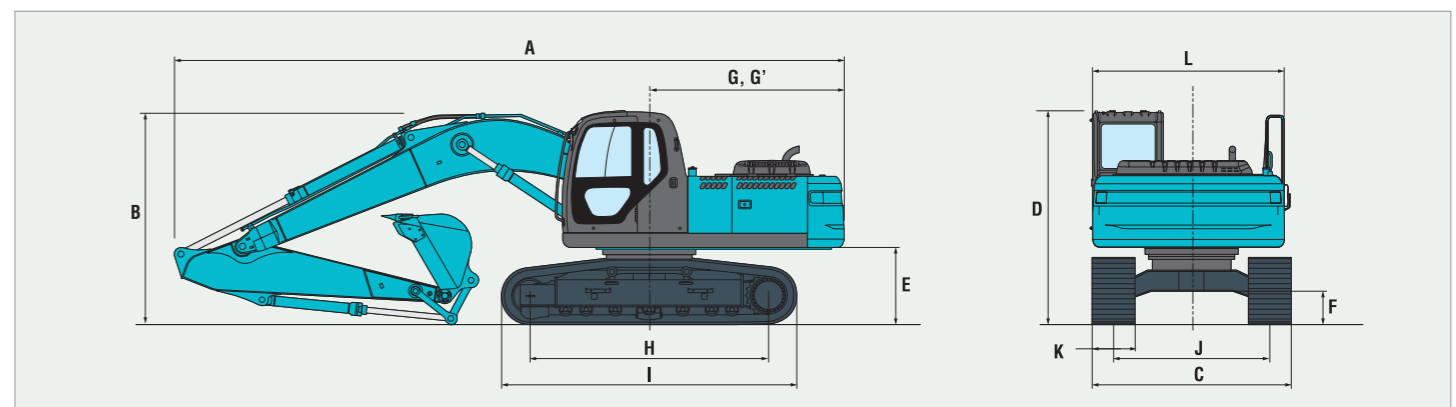

Operating Weight & Ground Pressure

In standard trim, with standard boom, 2.94 m arm, and 0.8 m³ ISO heaped bucket

Shaped	mm		Triple grouser shoes (even height)		
			600	700	800
Shoe width	mm		600	700	800
Overall width	mm	SK200	2,800	2,900	3,000
		SK210LC	2,990	3,090	3,190
Ground pressure	kPa (kgf/cm ²)	SK200	47 {0.48}	41 {0.42}	36 {0.36}
		SK210LC	44 {0.45}	39 {0.40}	34 {0.35}
Operating weight	kg	SK200	20,800	21,200	21,400
		SK210LC	21,300	21,700	21,900

